

ioPower

8-port Serial Power Control Unit
for any AC-powered Devices / Servers



User Guide

Rev. 1.42

FCC Warning

This equipment has been tested and found to comply with the regulations for a Class B digital device, pursuant to Part 15 of the FCC Rules. These limits are designed to provide reasonable protection against harmful interference when the equipment is operated in a commercial environment. This equipment generates, uses, and can radiate radio frequency energy and, if not installed and used in accordance with this user's guide, may cause harmful interference to radio communications. Operation of this equipment in a residential area is likely to cause interference to household appliances, in which case the user will be required to correct the interference at his/her own expense.

CE Mark Warning

This is a Class B product. In a domestic environment, this product may cause radio interference, in which case the user may be required to take adequate measures.

Caution

Risk of Explosion if battery is replaced by an incorrect type. Dispose of used batteries according to the instructions.

Disclaimer

Contents in this User Guide are subject to changes without prior notice.

Table of Contents

Table of Contents.....	iii
Quick Installation.....	1
Flash Upgrade Operation Guide (Using Windows HyperTerminal).....	7
Serial Command Set.....	10

ioPower

8-port Serial Power Control Unit for any AC-powered Devices / Servers

Quick Installation

Thank you for purchasing **ioPower**. **ioPower** can be used together with a host PC to control the power on/off of up to 8 servers/AC-powered devices. With our highly reliable and quality product, user can enjoy countless benefits from using it.



ioPower – Serial Power Control Unit

Introduction

The **ioPower** provides 8 AC power outlets and can be deployed along with a host PC for serial power control of any AC-powered devices. The **ioPower** proves to be a reliable solution that offers cost-effective power control to enterprise-level customers.

To control your AC-powered devices, you only need to tap them to any of **ioPower**'s 8 power output outlets and then connect the **ioPower** to a host PC installed with the *Power Management* software. To power on/off the connected AC-powered devices, you only need to press the front-panel button (press and hold for 2 seconds to activate/deactivate power port upon button release); or you can use the power management software. The software is installed on a host PC and provides a virtual front-panel that allows user to click to power on/off any connected devices. It also provides timer function to preset the destined power on/off time or power-up duration for each of your devices either at specific time or for recurrences.

The **ioPower** is also capable of cascading with multiple units into a daisy-chained configuration to maximize the port capacity up to one hundred more. Thus you can easily control up to hundred of AC-powered devices and/or servers.

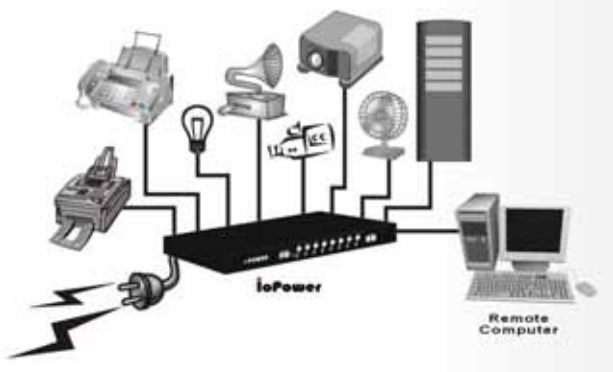

ioPower connected to a host PC



You might need to use extra adapter cords between **ioPower** and your devices, especially when the devices are not of the plug specification that fits the standard power outlets on the backpanel of **ioPower**.

Features

Hardware

- Can be used alone or cascaded with multiple units for power control of 8 to 100 more AC-powered devices
- Unit management using a host PC connected via serial interface (RS-232)
- Allows full control of 8 AC power outlets using ASCII commands over a serial interface
- Cascadable up to 16 units and control up to 128 AC power outlets, using UTP cables over RJ-45 interfaces
- Last known port status of each port retained and optionally restored when restarted after unit power down
- Timer setting restored when restarted after unit power down
- Numerical display to show power unit bank number when in multiple cascaded application
- Numerical display to monitor total current loads (showing 0.0 ~ 15A)
- 8 green (ON/OFF) LED indicators to show the ON/OFF status of each A/C power outlet
- 8 red (Alarm) LED indicators to show the state of failure of each AC power outlet
- "One-Touch" power ON/Off control by front-panel buttons (with 2" time-delay for activation/deactivation upon button release)
- Internal battery to retain unit configuration and port status/timer settings.
- 19" rack-mountable design with metal case

ioPower Management Software

- Intuitive user interface with virtual front-panel, power buttons and LED indicators
- Current loads (per port/total) and bank number displays
- Auto-configuration of COM port
- Power On/Off Timer function
- Simultaneous Power on/off all ports of one/all banks
- Power On/Off confirmation dialog prompt
- Power activation/deactivation based on duration/specific time point/daily-weekly recurrence timer settings

Before you install

Before you connect your devices to **ioPower**, please verify that the specifications are appropriate for your usage, for example: the output voltage should be in accordance with that required by your devices; and the total power loads and the power loads per port should not exceed the maximum total/per port output within its specification. Also the installation and operation should adhere to the local safety regulations.

Out-of-the-box Installation

Take the ioPower out of the box and begin installation...

- Step 1.** Connect the **ioPower** to the power outlet via its power chord.
- Step 2.** Connect a host PC serial port to the serial port on the **ioPower** backpanel, using a serial (RS-232) cable, then power on the host PC.
- Step 3.** Insert the **ioPower** Support CD-ROM into the CD-ROM drive of the Host PC, and then install the ioPower Management Software on your host PC. (Refer to next section for more details).
- Step 4.** Connect your AC-powered devices each to one of the eight power output outlets on **ioPower** backpanel. Now you can control the power-on/off of your AC-powered devices by the (1) pressing and hold a front-panel button by over 2 seconds and release it to activate/deactivate the power port, or (2) using the management software interface on the host PC.

 The front-panel buttons implement a time-delayed and action upon button release mechanism to prevent accidental pressing of the button to

- Step 5.** Run the *ioPower Management Software*,
 Step 5-1. Run *ioPower Management Software*
 Step 5-2. Select **Setting/Connect** to connect to **ioPower**.
 Step 5-3 Select **Setting/Configuration** to configure the connection settings and the timer settings. (refer to the following sections).

Easy Front-panel Operation

To control the power on/off via the **ioPower** Management Software Interface or set the timer to control the power on/off time of any of your devices, please refer to the following instructions.

Front-panel



Rear panel – for the US Region

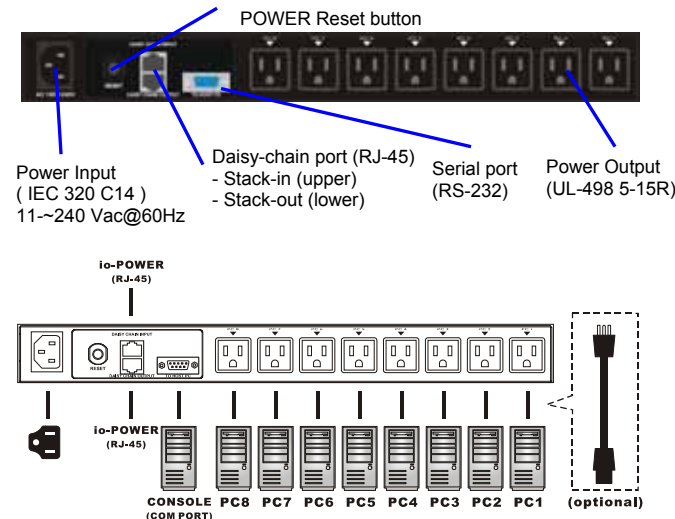

Rear panel – for the EU Region

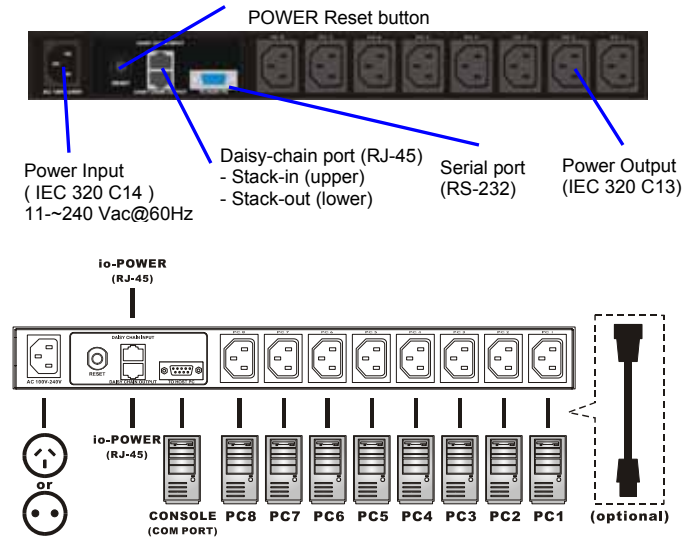

 You might need to use extra adapter cords between ioPower and your devices, especially when the devices are not of the plug specification that fits the standard power outlets on the backpanel of ioPower. These adapter chords are not included with your package carton and are available by optional purchase.

“One-touch” Power ON/OFF via Front-panel Button

To power ON/OFF any connected device, simply press and hold the corresponding Power Button for over 2 seconds to toggle your device On and Off upon button release.

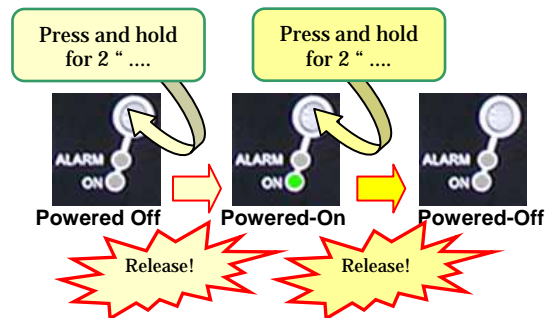

By default, each port is in powered-off state when **ioPower** is powered on.

Install ioPower Management Software

- Step 1.** Insert the Support CD-ROM disc to your host PC CD-ROM Drive. (or you can download the installer program from available support website)
- Step 2.** The installer program will auto-run when you insert the Support CD to your CD drive. (If not, then double-click the installation program executable file to start program installation.)
- Step 3.** Follow subsequent instructions to finish installation.
- Step 4.** After you have finished installation, you will see a desktop icon and an *ioPower* program group appears within the *Programs* menu.



Connect host PC to ioPower

Now you can begin connecting your ioPower to the host PC

Step 1. Run the ioPower Management software by double-clicking its desktop icon or access *Start /programs /ioPower/ioPower Management*.

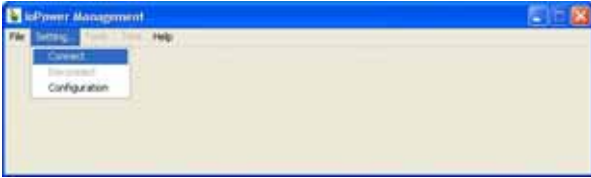

Step 2. Connect the host PC to ioPower by clicking *Setting/Connect*. And the software will automatically detect COM port for ioPower....

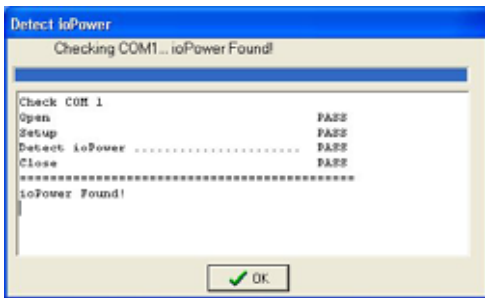

Check the COM port detection message on the message Box. After the COM port has been successfully detected, click OK to connect.

⚡ Note that if you see the FAIL message such as in the following picture, it means you have a faulty connection. Check your physical COM port connection to make sure that everything is in place, including the connectors and RS-232 cable integrity, etc.

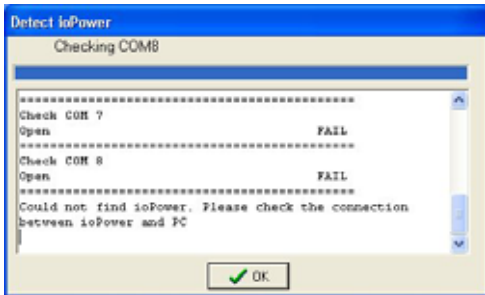

Failure of COM port detection

Step 3. Then you can see the virtual front panel of the connected ioPower unit(s).

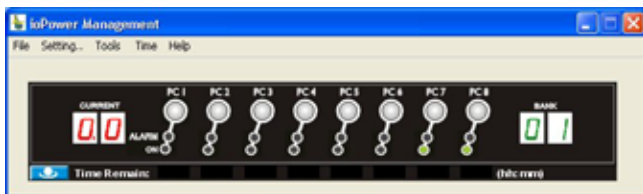

Power Management Software Interface

When running the **ioPower Management Software**, you should see a *virtual front-panel* identical to the physical front-panel. If you are cascading multiple units of **ioPower** (using the RJ-45 daisy-chain interfaces connected by a UTP cable), you can then see a corresponding number of stacked virtual front-panels, each of which showing its bank number, the total current loads and *time remaining* status per port.

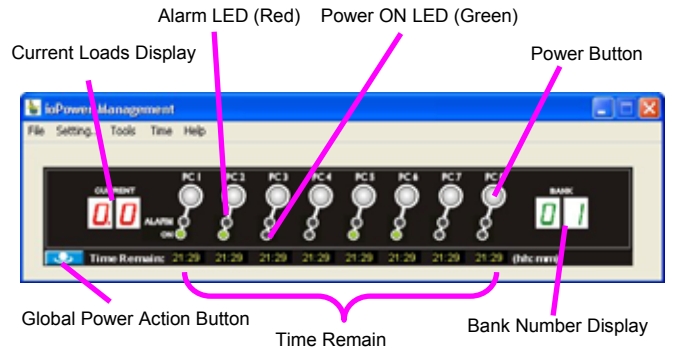

Virtual front-panels showing a single unit

Virtual front-panel operation

The virtual front-panel serves just like a real front-panel to provide "one-touch" power on/off function. Just click each virtual button to switch the power on and off



However, to avoid accidental mistakes, **ioPower Management software** will, by default, pop up a prompt for confirmation of this change after you click the virtual power button.

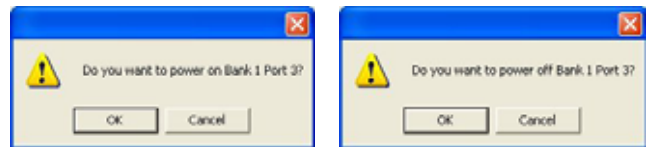

Power on/off confirmation dialog prompt

User can have free choice to disable/enable the confirmation prompt according to one's convenience.

Menu Function

File/Exit (Ctrl-X)

To exit the management program, click *File/Exit* or use the hotkey, *Ctrl-X*.

Setting/Connect

When **ioPower** is disconnected with host PC, click *Setting/Connect* to connect to host PC.

Setting/Disconnect

When ioPower is connected with host PC, click *Setting/Disconnect* to disconnect it from host PC.

Setting/Configuration

Click *Setting/Configuration* to access the ioPower Configuration interface. You can use this dialog box to configure your COM port setting, Auto-connection and Power ON/OFF confirmation prompt setting.

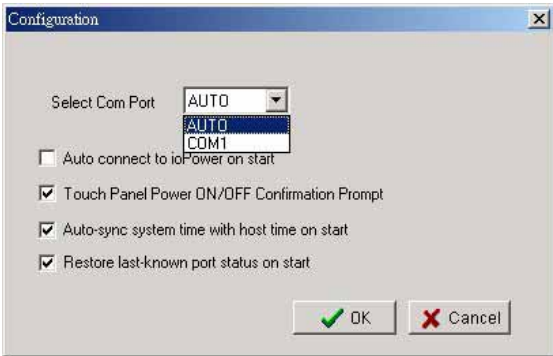

The General Setting Tab

<Select COM port>: you can select *Auto* for auto-configuration of COM port, or you can specify your COM port setting as any of the available COM ports.

<Auto-connect to ioPower on Start>: Check this option if you want to automatically connect to ioPower when the management software is started. (Auto-connect is disabled by default)

<Touch-Panel Power ON/OFF Confirmation Prompt>: Check this option if you want a confirmation prompt pops up to confirm the Power ON/OFF change with you. (Confirmation Prompt is enabled by default).

<Auto-sync system time with host time on start>: Check this option if you want to synchronize ioPower system with PC system time every time when you start ioPower Management Software.

<Restore last known port status on start on start>: Check this option if you want to restore the last known port status of each port when ioPower unit is restarted.

Tools/Upgrade

Once ioPower firmware upgrade is available, you can either get it from your local dealer or download it from available network resources. First, copy the firmware upgrade file to your host computer, and then access Tool/Upgrade to open the file locator dialog box.

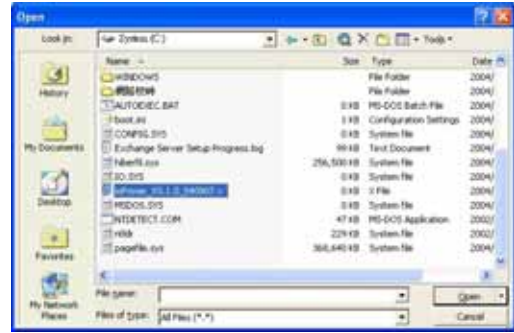
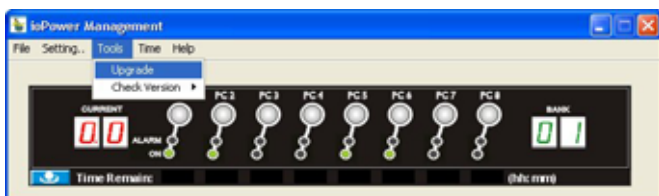

Then select the correct firmware upgrade file, e.g. *ioPower_V.x.x.x_dddxxx*. Then click *Open* to start firmware upgrade.

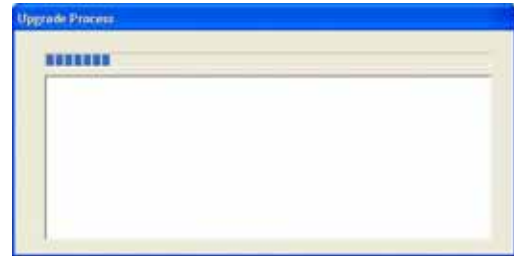

💡 You can also use the Windows HyperTerminal to perform firmware upgrade, please refer to the Firmware Upgrade Operation Guide that comes with your firmware upgrade file. Normally, your ioPower unit is loaded with the latest firmware, you should have no need to reload/upgrade your firmware unless (1) there's a new firmware upgrade ready (2) your firmware is corrupted and need reloading.

Tools/Check Version

To check the firmware version of Bank *x* (*x* = 1 ~ 16) of cascaded ioPower units, just click *Tools/Check Version/Bank x* to show the firmware version information in a small message box.

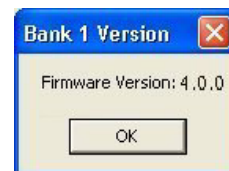

Time/ Set Timer

On this *Time/Set Timer* setting, you can specify whichever port on whichever bank (of all available banks) to power on/off at a preset time point (within 23 hours 59 minutes) or after certain duration (within 99 hours 59 minutes). After you have hit the *Apply* button, the enabled settings will be registered and put into action accordingly, and each entry date/time will be shown.



The **Timer Setting Tab**

Just use the series of check boxes and drop down combo boxes to specify the bank/port and time/duration for a power on/off.

There are several timer setting modes for selection:

- After ... to specify power on/off after specific duration
- At ... to specify power on/off at preset time
- Every day ... to specify daily power on/off at preset time
- Every week ... to specify weekly power on/off at preset day & time

To validate a specific timer setting item, just check the *Enable* checkbox and press *Apply* to validate them, and press *OK* to save and exit.

To invalidate a specific timer setting item, just uncheck the *Enable* check box, press *Apply* and then *OK* to save and exit.

To set timer settings on Bank x, hit the *Bank x* tab to select the specific timer setting page of Bank x, and then configure the timer accordingly.

To clear all timer settings on Bank x, just hit the *Clear Bank x* button and then hit *Apply* button to validate.

To save the timer settings on a bank to a file, just hit the *Save* button to save the settings on your current bank into a file.

To load timer settings of a bank from a file, just hit *Load* button and find the timer setting file to load.

To clear all timer settings of all banks, just hit the *Clear All* button, and then hit *Apply* button to validate.

After the timer setting is enabled for a specific port, you will see a count down timer ticker under that specific port on the virtual front-panel of your *ioPower Management Software* interface, and the alarm LED (red) will be flashing for a reminder. When within one minutes to power action, the ticker number will be flashing.

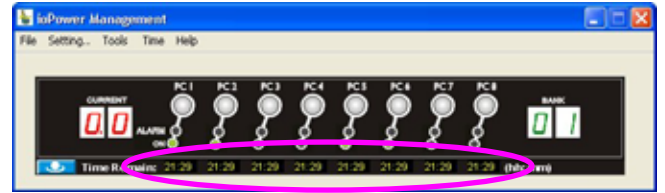

Tickers showing remaining time for power actions (still more than 21 minutes to go for a Power-On on all ports)

Note that the timer settings will also be executed nonetheless when (1) the host PC is shut down, or (2) the *ioPower Management Software* is disconnected to the *ioPower*. And the *ioPower* unit will also retain the last known port status of each port and will optionally restore each port to its last known status when *ioPower* is powered on again. **However, if the *ioPower* Unit has been powered down itself, it would lose all its previous timer settings and need to be reconfigured or reloaded with (previous) timer settings once again.**

Note that if you use the timer function to power on/off your device, the confirmation dialog prompt will not pop up for your confirmation just as you use the virtual front-panel button. Since it is assumed that you have intended to power on/off the specific device as you have planned... Therefore, timer will go directly to power on/off the device without warning you once the time is due.

When you input a value that is beyond the acceptable range of a setting field, a warning prompt will appear to warn you for incorrect input.



Range of hour settings



Range of minute settings

Global Power Action Button

ioPower also allows you to perform global Power ON/OFF actions on all ports of a specific bank or of all cascaded banks.... Click the **Global Power Action** button on the lower left of the virtual touch panel will evoke a *Quick Menu* for global power action such as power on/off all ports of a specific bank or all banks.

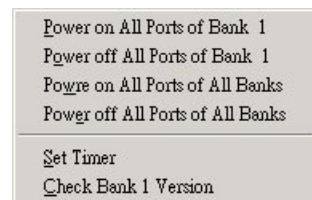

Global Power Action Menu

On the *Global Power Action Menu*, you can choose the following power on/off options:

- Power on all ports of a Bank x, x = 1~16
- Power off all ports of a Bank x, x = 1~16
- Power on all ports of all banks.
- Power off all ports of all banks.

Just select any of these options for simultaneous power on/off all ports on a specific bank or on all banks, and a confirmation prompt will appear to ask you for confirmation. Click *OK* to validate the action you selected.



The Confirmation Dialog Prompt

You can also access the timer setting interface on the Global Power Action Menu as well as to check the firmware version of any specific bank of the daisy-chained ioPower units.

System Requirements

Operation Mode	Requirements
Used with a Host PC	<ul style="list-style-type: none"> a Win-based Host PC (with ioPower Management Software installed) Serial (RS-232) Cable for connection with host UTP cable (only for cascading multiple units of ioPower)

Specifications

Model Name	ioPower
Input Voltage	100 ~ 240 VAC @ 50~60 Hz
Output Voltage	100 ~ 240 VAC @ 50~60 Hz (Depending on power input)
AC Output	8 total
Front-panel control	8 Power buttons
Host connection	Serial RS-232 interface (DB-9)
User interface	Host PC / ioPower Management Software
Cascade level	Up to 16 units
Cascade interface	RJ-45 (via UTP cable)
Max. current loads per port	6 amp per port
Current Overload Protection	15 amp max.
Operating Temperature	0~45°C
Operating humidity	10~90% RH
Storage Temperature	-20 ~ 70°C
Storage Humidity	0~90% RH
Dimensions (L x W x H)	410 x 165 x 44.5 mm

Troubleshooting

An Alarm LED is Lit (Red)

In normal condition, the Alarm LED should never be lit. However, when the Alarm LED is lit, it indicates that the corresponding power output port is put out of function by a hardware error, which prevents this port to power on or off.

If you see a lit Alarm LED, you should first disconnect the device connected with it and then try to troubleshoot by pressing several times its power button on the front-panel of **ioPower**, to see if the Alarm LED still remains lit persistently. If so, it indicates that this port is malfunctioning for good and need technical service from your local dealer.



Port Error (unable to power on)



Port Error (unable to power off)

While an alarm LED is lit, the timer setting interface on your **ioPower** Management Software will also show forth the

“invalid” message and block all sequent setting possibility on that malfunctioned port.

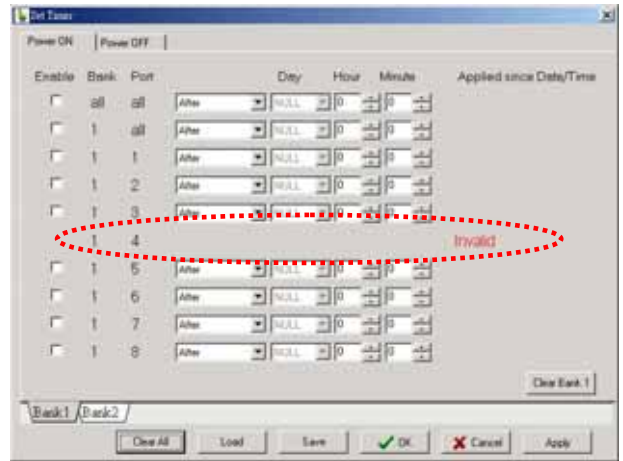

When a port is currently scheduled with a Timer setting for later power on/off, its alarm LED (red) will be flashing for a reminder. Also when you perform a firmware upgrade on ioPower, all the alarm LEDs will be flashing while it is still in process. In these conditions, flashing red LEDs do not indicate a problem.

Current Overloads Warning - A Flashing Numerical LED display (Red)

If the total current loads exceed 15 AMP-- the maximum allowable current loads of **ioPower**--the numerical display of the current loads (Red) will be flashing. If you see the flashing Numerical LED display, it means **ioPower** is now suffering from a current overloads. If that is the case, you should try to shutdown some devices to keep the current loads within its reasonable range.

Circuit Breaker Open Due to Current Overloads

If the total current loads exceed 15 AMP, the circuit breaker device might be activated to physically break off the internal circuit for safety and stop the function of **ioPower**. To restart the unit, just press the Power Reset button on the back panel.

Firmware Upgrade Not Successful or Firmware Corrupted

If your firmware upgrade has not succeeded or your firmware is somehow corrupted and could no longer function anymore, your current loads LED display will show forth a message such as “OP”. If you see such message on your current loads display, please upgrade your firmware once more or check the integrity of your firmware code.

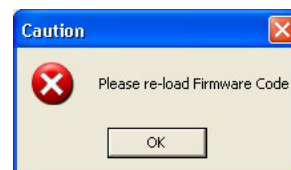
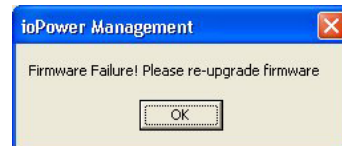

ioPower

Flash Upgrade Operation Guide (USING WINDOWS HYPERTERMINAL)

Important Note: Besides using Windows HyperTerminal for ioPower flash upgrade, you can also use the *Tools/Upgrade* option on the ioPower Management Software Menu. Please refer to the *Quick Installation* section on this *User Guide*.

 The ioPower allows its user to upgrade firmware contents whenever is needed to enhance its functionality and/or performance. With the firmware upgrade feature, your investment on the unit is further ensured and its life-time value just maximized. You don't have to buy a newer unit just to have better features, instead you can have them all added to your current unit with an easy flash upgrade! The correct Flash upgrade procedure is described below. Please follow the instructions to complete your firmware upgrade.

Flash Upgrade Procedure

 Before you can perform a flash upgrade, **you should have (1) a powered-on PC with an available RS-232 port (DB9) (2) the ioPower Unit to be upgraded, and (3) a RS-232 cable (DB9 to-DB9) connected already to RS-232 ports on both your PC and the ioPower Unit.**

AND also.....

Pease be sure to have (4) the latest flash upgrade file (*.x) ready on your local computer. You can copy them from the diskette/CD-ROM provided by the technical support or download it from available support website.

Check the connection between the ioPower Unit and PC

 Make sure you have powered on the PC and also the ioPower Unit before you perform the flash upgrade procedure.

Step 1. Connect your PC and the ioPower Unit using a RS-232 cable.

Setting the Windows HyperTerminal

 Once you have successfully established a serial connection, the settings will be stored on your PC and a shortcut with the connection's name generated under your HyperTerminal program menu. Next time, you can establish the connection again simply by clicking the connection shortcut without going over the procedure in this section again. If that is the case, just click the connection shortcut and go right to the last section, *Flash Upgrade File Transfer*.

Step 2. On your PC (which should already be connected to your ioPower Unit with a DB9-to-DB9 RS-232 cable), activate the Windows HyperTerminal (Start/Programs/Accessories/Communications/Hyper Terminal). Designate your HyperTerminal connection with a specific name, e.g. *Power Control 01*.



Click OK.

Step 3. Select COM 1 or COM 2 (depending on r actual COM port configuration). In this case, we select COM 1.



Click OK.

Step 4. Configure your port setting with the following parameters:

Bits per seconds: 9600

Data bits: 8

Parity: None

Stop bits: 1

Flow Control: Hardware

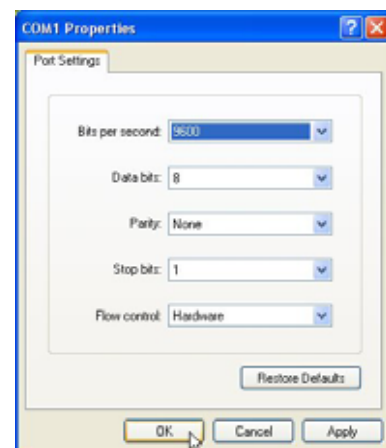

Click *Apply* then click *OK*. Then HyperTerminal windows appears.....



Step 5. Hit Enter key twice to go into command mode

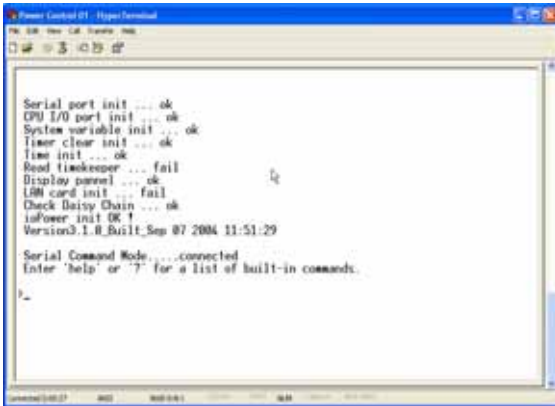

⚡ If the firmware version is lower than 040421, here you should type in /iopower\ on the command line and then hit *Enter* to go into command mode.

On the HyperTerminal window, you'll see the *Testing OK* message and the existing firmware version number.....

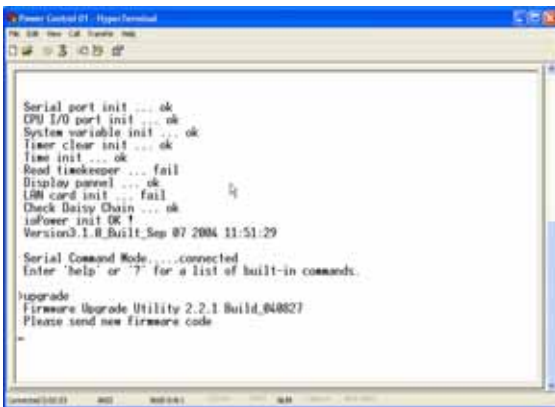

Step 6. Type *Upgrade* on the command line and hit *Enter*...Now you have your HyperTerminal ready for file transfer. Keep your HyperTerminal window open and go to the next step....

Flash Upgrade File Transfer

Step 7. To start loading the file, access the drop-down menu on HyperTerminal: *Transfer/Send Text File*....

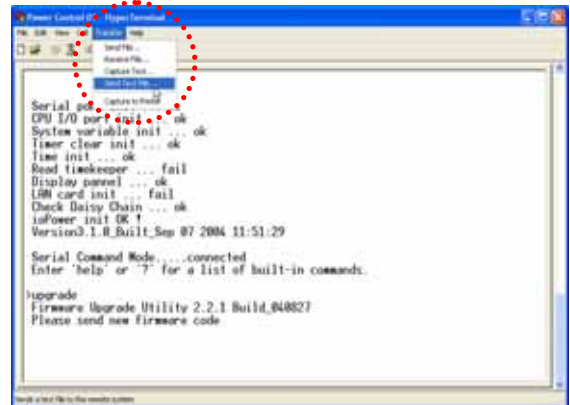

....and a dialog box will prompt you to select the flash upgrade file, *.x (with a file extension name as .x). In this case, we have our flash upgrade file as *ioPower3.0.1_040907.x* (it could be any other file name with an .x extension!). Note that since it has an extension name other than .txt, we have to select the "All file [*.*]" option in order to see it on the file listing....

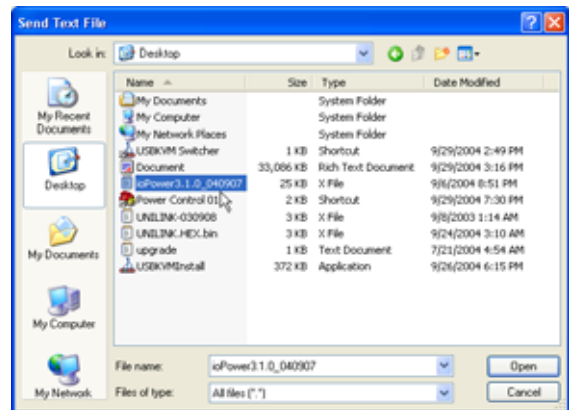

Then select our target file: *PowerGate.hex.bin.x*. And then Click *Open* to begin the file transfer

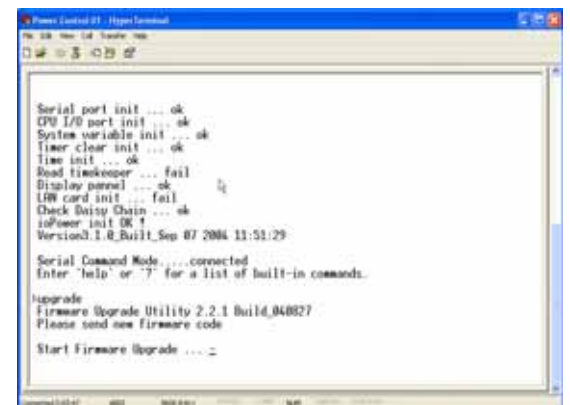

When the file transfer is completed, you will see the message: *OK!! Please Restart* on the HyperTerminal window to tell you that Flash Upgrade process is successful....

```

Power Control 01 - Hyper Terminal
File Edit View Help Window Help
Serial port init ... ok
CPU I/O port init ... ok
System variable init ... ok
Timer clear init ... ok
Time init ... ok
Read timekeeper ... fail
Display panel ... ok
LBN card init ... fail
Check Daisy Chain ... ok
ioPower init OK !
Version 2.1.0_Built_Sep 07 2004 11:51:29

Serial Command Mode.....connected
Enter 'help' or '?' for a list of built-in commands.

Upgrade
Firmware Upgrade Utility 2.2.1 Build_040827
Please send new firmware code

Start Firmware Upgrade ... OK !!
Serial port init_

```

- Step 8.** After you have successfully upgraded the flash firmware and before you utilize the ioPower Unit, you should perform a system reset by powering down the unit. Wait for a few seconds and then complete the reset again.

Troubleshooting

⚡ If the flash upgrade procedure seems never ending or you see the following message: *Please send new firmware*, shown on the screen, it indicates that the flash process had failed. If that is the case, please power off the ioPower Unit and then power it on restart the whole flash procedure again. You also press any button on front panel about 3 seconds when you power on the ioPower Unit.

```

Power Control 01 - Hyper Terminal
File Edit View Help Window Help
Firmware Upgrade Utility 2.2.1 Build_040827
Please send new firmware code

```

ioPower

Serial Command Set

Before you use the serial command ...

(1) To use the serial commands for ioPower control, you have to **establish a HyperTerminal connection between ioPower and the host PC, using a RS-232 cable for connection. Use the following parameters for HyperTerminal connection:**

Bits per seconds: 9600
 Data bits: 8
 Parity: None
 Stop bits: 1
 Flow Control: Hardware

(2) After your HyperTerminal session has been established, you have to **hit the *Enter* key twice to go into command mode**, then you can input the serial commands within the HyperTerminal window according to the following command usages

Command usage notes:

1. The commands are **NOT** case-sensitive. That means you can use lower case in typing your commands! The commands does not require a strict double-digit entry of bank number or port number (such as ON 01 03 - Power on bank 1 port 3) but can accept their single-digit entries (such as ON 1 3), and also allow multiple blank spaces in between its command parameters (such as ON 1 3).
2. When using the HyperTerminal, note that **ScrollLock should not be ON**. Otherwise, it will block you from entering commands. ScrollLock is OFF by default in HyperTerminal. However, if you cannot type in commands, please check the ScrollLock status, which can be viewed on status bar at the bottom of your HyperTerminal window. If ScrollLock is ON, hit ScrollLock key again to relieve it.

HELP - Show Help Menu

[Description] Show the Help Menu on the HyperTerminal screen
 [Usage] HELP
 [Example] Help

? - Show Help Menu

[Description] Show the Help Menu on the HyperTerminal screen
 [Usage] ?
 [Example]
 ?

QUIT - Exit serial command mode

[Description] exit serial command mode
 [Usage] QUIT
 [Example]
 QUIT

Notes: Once you exit serial command mode, you have to hit Enter twice again to enter the serial command mode again.

ON - Power ON

[Description] Power on one/all AC outlet port(s) immediately

[Usage] ON [bank_number] [port_number]

[Examples]

ON 1 4 - Power on port 4 on bank 1 immediately

ON 1 0 - Power on all ports on bank 1 immediately

ON 0 0 - Power on all ports on all cascaded banks immediately

Notes:

1. A port number of 0 represents all ports; while a bank number of 0 represents all cascaded banks.
2. The command: ON 0 x, x = 1~9, is not valid.

OF - Power OFF

[Description] Power off one/all AC outlet port(s) immediately

[Usage] OF [bank_number] [port_number]

[Examples]

OF 1 4 - Power off bank 1 port 4 immediately

OF 1 0 - Power off bank 1 all ports immediately

OF 0 0 - Power off all ports on all cascaded banks immediately

Notes:

1. A port number of 0 represents all ports; while a bank number of 0 represents all cascaded banks.
2. The command: OF 0 x, x = 1~9, is not valid.

TA - Timer Activate at specific time point

[Description] Set the timer to turn on/off a specific port at specific time

[Usage] TA [bank_number] [port_number] [ON | OF] [Time_point]

[Examples]

TA 1 4 ON 01:22:50 - Set timer to power on port 4 on bank 1 exactly at 01:22:50.

TA 1 0 ON 00:10:00 - Set timer to power on all ports on bank 1 exactly at 00:10:00

TA 0 0 OF 01:00:00 - Set timer to power off all ports on all cascaded banks at 01:00:00

Notes:

1. A port number of 0 represents all ports; while a bank number of 0 represents all cascaded banks.
2. The command: TA 0 0x, x = 1~9, is not valid.
3. The system time should be calibrated before use for the first time.

TF - Timer Activate after specific time duration

[Description] Set the timer to turn on/off a specific port after specific time duration

[Usage] TF [bank_number] [port_number] [ON | OF] [Time_duration]

[Examples]

TF 1 4 ON 03:25:56 - Set timer to power on port 4 on bank 1 exactly after 3 hour 25 minutes and 56 seconds.

TF 1 0 ON 00:10:00 - Set timer to power on all ports on bank 1 exactly after 10 minutes

TF 0 0 OF 01:00:00 - Set timer to power off all ports on all cascaded banks after 1 hour.

Notes:

1. A port number of 0 represents all ports; while a bank number of 0 represents all cascaded banks.
2. The command: TF 0 0x, x = 1~9, is not valid.

ED - Timer Activate everyday at a specific time point

[Description]Set the timer to turn on/off a specific port every day at specific time point

[Usage] ED [bank_number] [port_number] [ON | OF] [Time_point]

[Examples]

ED 1 4 ON 02:12:20 - Set timer to power on port 4 on bank 1 exactly every day at 02:12:20.

ED 1 0 ON 00:10:00 - Set timer to power on all ports on bank 1 exactly every day at 00:10:00.

ED 0 0 OF 01:00:00 - Set timer to power off all ports on all cascaded banks every day at 01:00:00.

Notes:

1. A port number of 0 represents all ports; while a bank number of 0 represents all cascaded banks.
2. The command: ED 0 0x, x = 1~9, is not valid.

EW - Timer Activate every week at a specific time point

[Description]Set the timer to turn on/off a specific port every week at specific time point

[Usage] EW [bank_number] [port_number] [ON | OF] [day] [Time_point]

[Examples]

EW 1 4 ON 1 01:22:50 - Set timer to power on port 4 on bank 1 exactly every Monday at 01:22:50..

EW 1 0 ON 3 00:10:00 - Set timer to power on all ports on bank 1 exactly every Wednesday at 00:10:00.

EW 0 0 OF 5 01:00:00 - Set timer to power off all ports on all cascaded banks every Friday at 01:00:00.

Notes:

1. A port number of 0 represents all ports; while a bank number of 0 represents all cascaded banks.
2. The command: EW 0 0x, x = 1~9, is not valid.
3. A day of 0 represents Sunday; while a day of 1 represents Monday, later calculate for this reason.

TQ - Timer Quit

[Description]Cancel a specific/all timer setting(s)

[Usage] TQ [bank_number] [port_number] [ON | OF]

[Examples]

TQ 1 4 ON - Cancel timer power-on setting on port 4 of bank 1

TQ 1 4 ON - Cancel timer power-on setting on port 4 of bank 1

TQ 0 4 - Cancel timer power-on&off setting on port 4 of bank 1

TQ 1 0 OF - Cancel timer power-off setting on all port of bank 1

TQ 0 0 ON - Cancel timer power-on setting on all port of all banks

TQ 0 0 - Cancel timer power-on&off setting on all port of all banks

Notes:

1. A port number of 0 represents all ports; while a bank number of 00 represents all cascaded banks.
2. The command: TQ 0 x, x = 1~9, is not valid.
3. If you have not specified either "ON" or "OF" as the command parameter, it is assumed that this Timer Quit directive will be directed on both the Power-ON and Power-OFF setting of that specific port.

ST - Status

[Description] Show the system status of a specific bank, such as current loads, on/off status and timer settings

[Usage] ST [*bank_number*]

[Examples]

ST 1 - Show the system status of bank 1

ST 16 - Show the system status of bank 16

ST 0 - Show the system status of all banks

UPGRADE - Upgrade Firmware

[Description] Upgrade the system firmware

[Usage] UPGRADE

[Example]

UPGRADE

Note: Please also refer to *ioPower Flash Operation Guide* for details.

SETTIME - Set Up System Date and Time

[Description] Set up the system date and time

[Usage] SETTIME [*20yy/mm/dd*] [*hh:mm:ss*]

[Example]

SETTIME 2004/09/27 18:10:00 - Set up the system Date and time to be 2004/09/27 18:10:00

GETTIME - Get System Time

[Description] Show the system date, day and time

[Usage] GETTIME

[Example]

GETTIME

VER - Firmware Version

[Description] Show the firmware version of a specific bank.

[Usage] VER [*bank_number*]

[Example]

VER 01 - Show the firmware version of bank 1

VER 16 - Show the firmware version of bank 16

VER 00 - Show the firmware version of all bank

